

Pigtail bolt

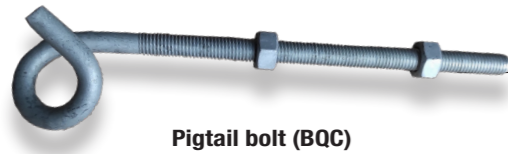

Pigtail bolt (BQC)

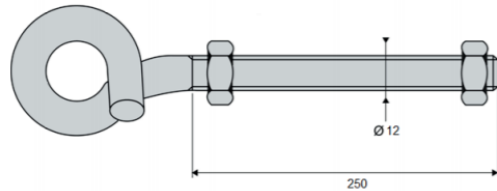

Application

This material made of hot dip galvanised steel is designed to fix anchoring and suspension clamps.

Code	Designation	Weight (kg)	Sales unit
WITH 1 SCREW			
U480_12-35	PIGTAIL BOLT BQC 12x35 WITH 1 SCREW	0.180	10
U480_12-55	PIGTAIL BOLT BQC 12x55 WITH 1 SCREW	0.300	10
WITH 2 SCREWS			
U480_12-110	PIGTAIL BOLT BQC 12x110 WITH 2 SCREWS	0.290	10
U480_12-200	PIGTAIL BOLT BQC 12x200 WITH 2 SCREWS	0.380	10
U480_12-250	PIGTAIL BOLT BQC 12x250 WITH 2 SCREWS	0.420	10
U480_12-300	PIGTAIL BOLT BQC 12x300 WITH 2 SCREWS	0.480	10
U480_12-350	PIGTAIL BOLT BQC 12x350 WITH 2 SCREWS	0.520	10
U480_14-250	PIGTAIL BOLT BQC 14x250 WITH 2 SCREWS	0.580	10
U480_14-300	PIGTAIL BOLT BQC 14x300 WITH 2 SCREWS	0.650	10
U480_14-350	PIGTAIL BOLT BQC 14x350 WITH 2 SCREWS	0.710	10
WITH DOWEL			
U480_12-110-CH	PIGTAIL BOLT BQC 12x110 WITH 1 DOWEL	0.250	10
WITH WASHER			
U480_12-55-40	PIGTAIL BOLT BQC 12x55 WITH 1 WASHER - THREAD 40	0.250	10

Tige queue de cochon

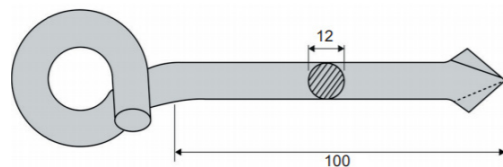

Application

This hot-dip galvanised steel material is used to fix the anchoring and suspension clamps.

Code	Designation	Weight (kg)	Sales unit
F344	TQC 12x150	0.290	10
F345	TQC 12x200	0.310	10
F346	TQC 12x250	0.340	10

Pigtail plate

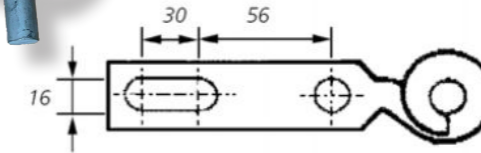
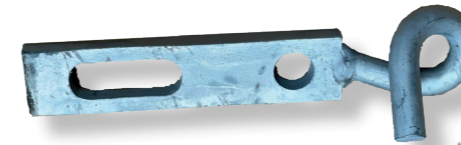

Application

This hot-dip galvanised steel material is used to fix the anchoring and suspension clamps.

Code	Designation	Weight (kg)	Sales unit
F340	PIGTAIL PLATE PQC	0.370	10

Installation

The anchoring clamp is fixed on the pole thanks to the pigtail bolt.

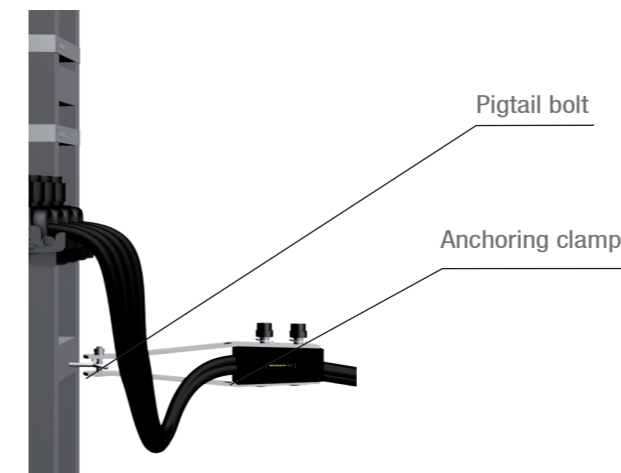

Wall pole and accessories

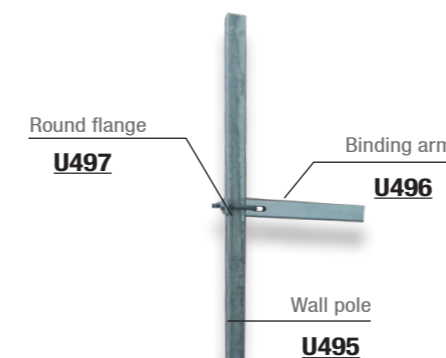

U499-45

Application

This equipment comprises a wall pole, binding arms and flanges.

Code	Designation	Length (mm)	Weight (kg)	Sales unit
U495_45-45-4000	WALL POLE 45x45x4000	4000	17.5	1
U495-1500	WALL POLE 50x50x1500	1500	7.2	1
U495-2000	WALL POLE 50x50x2000	2000	9.5	1
U495-2500	WALL POLE 50x50x2500	2500	11.9	1
U495-3000	WALL POLE 50x50x3000	3000	14.3	1
U496-350	BINDING ARM 350	350	2.3	1
U496-1100	BINDING ARM 1100	1100	5.3	1
U497-50	ROUND FLANGE 50		0.3	1
U499-45	U-BOLT FOR SEALING - 45		0.185	1